



Texas Instruments Innovation Challenge: Europe Design Contest 2015 Project Report

BabyZen – a flexible sensor BoosterPack

Team Leader: Florian Rappl (florian.rappl@physik.uni-regensburg.de)
Team Members: Niki Kilbertus (niki.kilbertus@physik.uni-regensburg.de)
Advising Professor: Dr. Fritz Wunsch (fritz.wuensch@physik.uni-regensburg.de)
University: University of Regensburg, Germany
Date: 31.07.15

Qty.	TI Part Number & URL	Qty.	TI Part Number & URL
1	CC3200-LaunchPad	1	OPT3001
1	HDC1000	1	LMV324
1	ADS1115	1	LMT70A

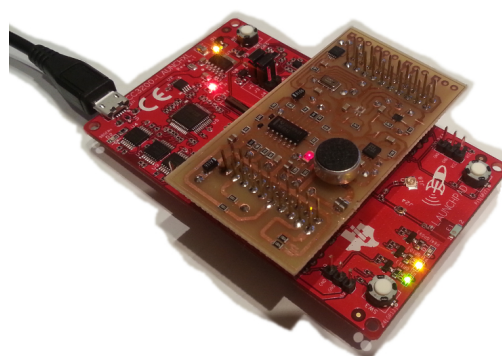
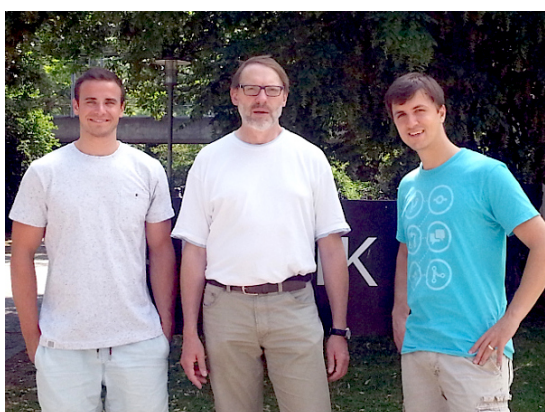

BabyZen is an application to monitor important quantities defining the environment of a baby with an advanced general purpose sensor board in form of a flexible Texas Instruments BoosterPack, which is fully compliant with the official design guidelines. Our manually etched and soldered PCB comprises high precision sensors to measure sound pressure, temperature, humidity, ambient light, acceleration and barometric pressure. It also features an ADC, which supports up to four additional external analog sensors. The ultra low-power BoosterPack is stacked onto the CC3200 LaunchPad, which preprocesses the sensor data and sends it to a server via HTTPS. Subsequently the data is stored in a database and analyzed by a machine learning framework to detect correlations between environmental conditions and the baby's well-being. An integrated mobile application provides the parents with visualizations and recommendations on how to improve their baby's life. A [video demonstration](#) is available online [1].

1 INTRODUCTION AND MOTIVATION

Up to now parents always had to rely on their gut feeling when trying to interpret the well-being of their baby. Thus they sometimes unintentionally provide environmental conditions, which are obstructive for the development of a newborn. We believe every baby should experience nothing but optimal conditions, which is why we designed and built BabyZen. The basic idea is to monitor important quantities and use machine learning techniques to analyze the data with respect to known medical guidelines [2, 3, 4] as well as strongly correlated occurrences in the past. We deduce recommendations on how to improve the baby's life by minimizing negative disturbances, consequently increasing security against the sudden infant death syndrome and several childhood illnesses. The word Zen can be loosely translated as "meditative state" [5]. Our goal is to provide an enjoyable experience for parents, who want to minimize health risks by creating optimal conditions for their children.

The end-to-end implementation requires proficiency in various fields from electrical engineering and hardware-related programming to a deep understanding of network protocols and the implementation of a sophisticated storage and machine learning infrastructure. A mobile application providing visualizations and alerts for the perfect user experience. Our personal goals for this multifaceted project are to do as much by ourselves as possible and ensure reproducibility. We minimize dependencies in our code, use free, cross platform tools only and even etch and solder the PCB at home without automated machines. As physicists without professional training in electrical engineering, this was quite a challenge. By scrutinizing every step and part in advance, we forestalled errors and ensured optimal results.

Section 2 is the core of the report. First we describe the LaunchPad in subsection 2.1 and our BoosterPack design in subsection 2.2. We will successively elaborate on the used sensors in subsection 2.3. An ensuing discussion of the device software in subsection 2.4 finishes off the main section. The overall architecture of BabyZen as well as the Microsoft Azure services are presented in section 3. Finally we sum up what we have accomplished and what is left for future work in section 4.

2 DEVICE

We use the CC3200 as the core of our device to collect and preprocess data from various low-power sensors, which measure temperature and humidity, ambient light, sound pressure, barometric pressure and movement. A general purpose ADC allows for the connection of up to four additional external analog sensors. All those parts are mounted on a single PCB, which is compliant to the LaunchPad BoosterPack design reference [6]. The whole device is sourced by two AA batteries and responsible for sending the preprocessed data to the Azure web interface via an HTTPS protocol.

2.1 Microcontroller Unit - the CC3200

We believe that the Internet of Things will be one of the most influential technologies in the near future. Providing appropriate hardware components plays a crucial role for IoT scenarios and with the CC3200 TI started a new era in this high potential

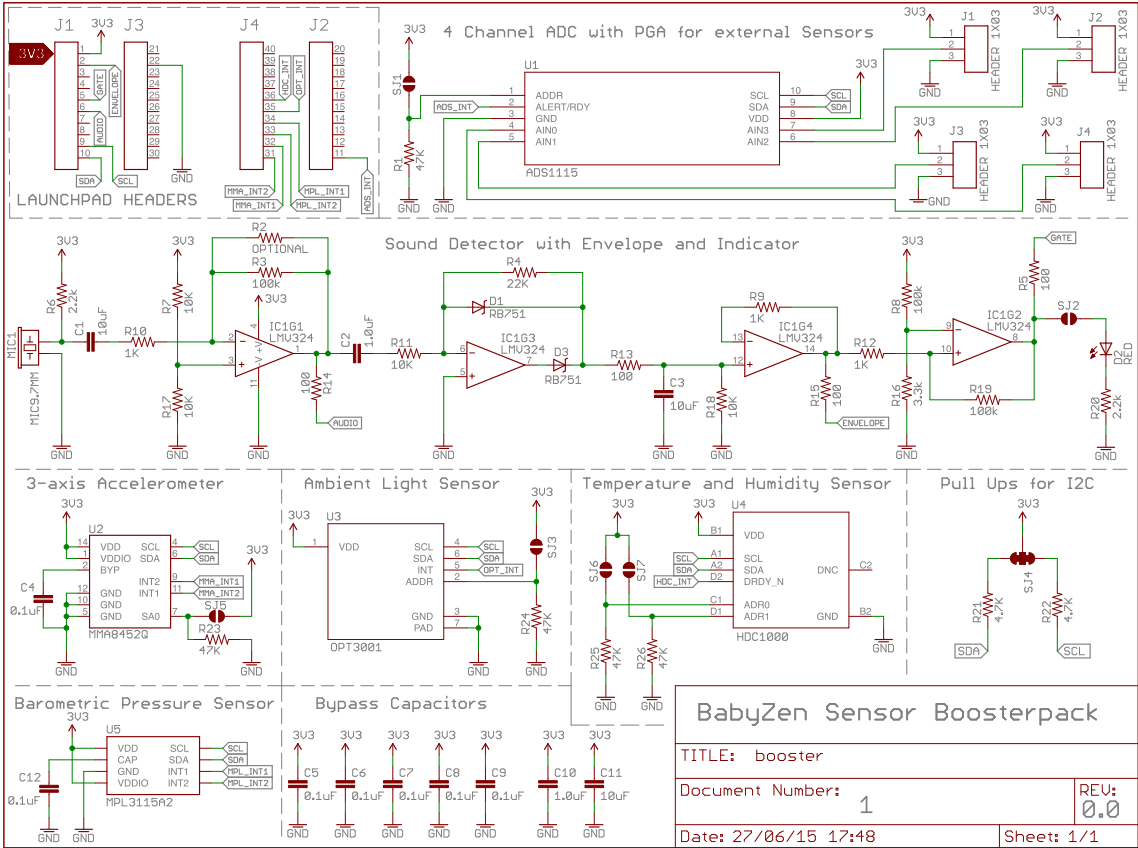

Figure 1: The schematic of the BabyZen BoosterPack, created with CadSoft Eagle (Light).

market. It comprises unrestricted connectivity and remarkable computing power on a single chip. The incredible power efficiency and the multitude of interfaces for peripheral devices renders it into a true IoT Swiss Army knife. Freely available IDEs with numerous coding examples [7], helpful manuals and easily accessible libraries make IoT development with TI a true pleasure.

We have decided to use the CC3200 LaunchPad, because it is a well documented and easy to use prototyping platform. As industry’s first FCC, IC, CE, and WiFi certified single-chip controller module, we can be sure to fulfill all safety standards concerning electromagnetic inference. It integrates all required system-level hardware components and supports TCP/IP and TLS/SSL stacks, HTTP(S) servers, and multiple Internet protocols. The CC3200 even features a powerful 256 bit encryption engine for secure connections and supports WPA2 as well as WPS 2.0. At its heart lies a powerful ARM Cortex-M4 operating at 80 MHz with up to 256 kB of RAM. As a conclusion, the CC3200 LaunchPad exceeds all our requirements. Therefore the choice of the processor could not have been easier.

2.2 Circuit Diagram and BoosterPack Design

We spent a long time analyzing which design is best suited for our application and came up with three possible solutions. We could have mounted everything we need, including the CC3200, on a large single PCB. This option was quickly discarded, because it is infeasible to redesign the LaunchPad from scratch. Manual production would have been impossible, which violates one of our design goals. As another

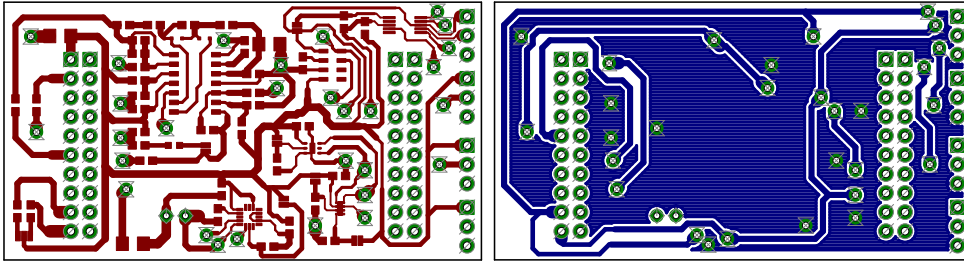

Figure 2: The etching masks for the BabyZen BoosterPack.

option we could create separate small breakout boards for each sensor and wire them to the LaunchPad individually. This approach is still tempting for debugging reasons. However, it would create a mess of loosely connected, moving parts and thereby strongly affect ambient light, sound and movement measurements.

Therefore we chose a third possibility, one board comprising all sensors wired to the LaunchPad. After evaluating our options, we came to the conclusion that a BoosterPack is the optimal solution to connect our board. While the advantages are obvious, we quickly realized that complying with the recommended BoosterPack dimensions [6] is rather challenging. However, by starting with a schematic for each sensor independently and extensive tests of the individual modules, we managed to create a functioning BoosterPack in the first try. Figure 1 shows the schematic of the BabyZen BoosterPack, which clearly reflects the modular design. In favor of a manual etching, soldering and drilling process, we demanded wide traces and large radii for the vias. The outcome is shown in figure 2. Unfortunately, our tools did not allow for silk screen and we could not properly route one channel of the ADC (bottom-right), which was later connected by an external wire. Another version with smaller traces and vias for automated production in a board house features detailed silk screen information and full functionality.

2.3 Sensors

We chose digital sensors in tiny packages and a small number of peripheral parts, whenever possible and reasonable to save space. Moreover, we agreed on a single shared minimalistic serial bus to render communication especially simple. The sensor market clearly distinguishes I²C as the natural choice. Besides the I²C interface a supply of 3.3 V was a crucial criterion for the sensors. We provide the highest possible flexibility by connecting all available interrupt pins to carefully selected GPIOs of the LaunchPad. Additionally all available address selection pins of I²C devices are set to ground by default, but can be pulled up with solder jumpers.

TEMPERATURE AND HUMIDITY For temperature and humidity measurements we use Texas Instrument's **HDC1000** sensor. It is a low-power, high accuracy digital device, which records relative humidity (0% to 100%) and temperatures (−40 °C to 85 °C) with up to 14 bit resolution and an excellent accuracy of $\pm 3\%$ and $\pm 0.2\text{ °C}$ respectively. Because there is no point in sampling temperature and humidity at higher rates than about 0.1 Hz and each conversion at maximal resolution takes less than 15 ms, the sensor will spend about 99.9% of the time in sleep mode with a typical current consumption of only 110 nA. Together with low operating voltages of 3.3 V,

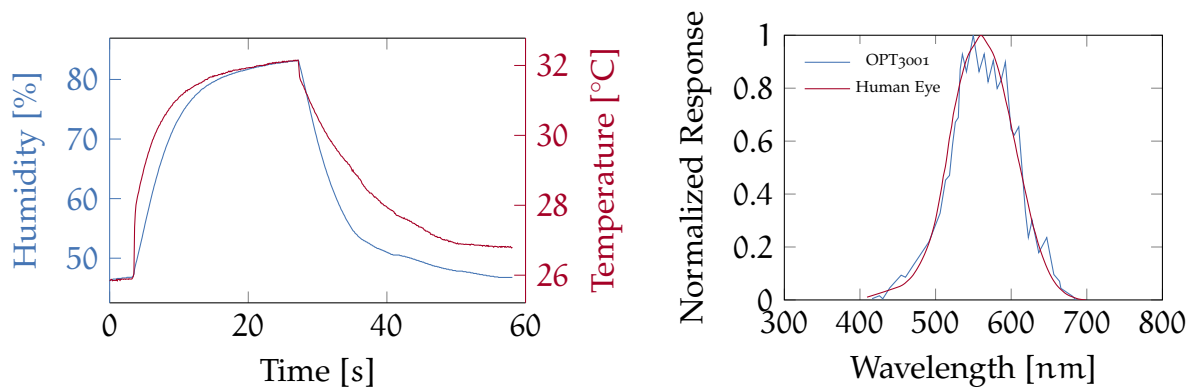

Figure 3: Left: The temperature and humidity measured by the HDC1000, when placing a finger right onto the sensor and releasing it again after about 28 s. Right: The response of the OPT3001 compared to the V-lambda curve.

average power consumption is reduced below $10\ \mu\text{W}$. For genuine measurements we placed the HDC1000 far from power consuming parts and tried to keep heat capacitance (from lanes and parts) around the sensor as low as possible. This yields reliable results as shown in figure 3, where we put a finger on the sensor to test responsiveness.

AMBIENT LIGHT Apparently ambient light is an important environmental factor influencing a baby’s activity. One has to be very careful with light related measurements. Often it is far from obvious, whether one actually records the correct quantity (candela, lux, radiation power, ...). Here, we care about how bright the environment appears to us as humans. To this end a common photo transistor or photo diode would not suffice, because they respond to a very broad spectrum of wavelengths. However, the human eye’s sensitivity is rather narrow and given by the so called V-lambda curve shown in figure 3. It peaks somewhere between 555 nm and 570 nm and, by definition, vanishes outside of the visible part of the spectrum. For accurate measurements of the ambient light, we need a sensor with a spectral response exactly like the human eye. This is the reason, why we chose TI’s OPT3001. Figure 3 shows the impressive agreement of the sensor’s response with the V-lambda curve. We emphasize the strong infrared rejection of about 99 %, which is probably the most striking feature compared to naive approaches with passive elements.

With a 23 bit effective range and automatic range detection we get very detailed information about the lighting situation. Again, strategic positioning of the sensor is vital. In our design we respect the recommendations not to place any surrounding parts closer than twice their height and avoid vias in the thermal pad or close to the sensor. Since the sensor is only required to distinguish illumination on a coarse grading, the precision is more than sufficient. Small perturbations, e.g. from reflections, do not heavily affect functionality. In our application the current consumption stays way below $3.5\ \mu\text{A}$ even in active mode. At 3.3 V this yields a total consumption of about $10\ \mu\text{W}$.

SOUND DETECTOR The sound detector plays two important roles. Not only does it detect ambient noises that could influence the baby, but also the baby’s sounds.

Besides movements this is the most important feedback from the baby. Thus the success of BabyZen relies heavily on proper sound detection. For slowly varying parameters such as temperature and lighting conditions, sampling rates below 1 Hz are perfectly reasonable. However, for sound detection, analog circuitry is a must.

Sound detection has many layers, we first classified our needs. While we agreed that for now amplitude and duration are sufficient for a rough distinction between background noises and the baby's screaming, we do want to employ a detailed Fourier analysis later on. Hence we designed an analog amplification circuit, which provides three different outputs. On the highest level, we have a digital on/off signal indicating exceedance of a certain sound pressure threshold as an interrupt signal to start the recording. On the second level, we directly output the current amplitude of the sound pressure, scaling like the root-mean-square. Eventually, on the lowest level we have access to the raw amplified sound signal as recorded by the electret microphone. Figure 4 shows that this works surprisingly well. The envelope follows the amplitude of the oscillation and gate indicates silence or noise respectively.

For the realization of this circuit we need four operational amplifiers, see figure 1. The microphone signal is decoupled by a 10 μF capacitor and then fed into a basic differential amplifier stage. The positive input is set to half the supply voltage around which oscillations occur. The output of this first stage is the raw sound signal labelled "AUDIO" in the schematic (blue line in figure 4) and is recorded by an analog pin of the CC3200. An optional resistor in the feedback determines the gain of up to 100. Subsequently the signal is again decoupled by 1 μF and passed on to an improved half wave precision rectifier with gain. Because R_4 is connected to virtual ground, the output will be zero for positive input (for which D_1 is on). On the contrary, for negative input, D_1 is off and the output follows the input with an amplification of -2.2 . After rectification, the capacitor C_3 serves as a low pass filter and helps creating the "ENVELOPE" signal (red line in figure 4) in the following amplification stage. Eventually, the fourth differential amplifier is set up with a gain of 100 and compares the (strictly positive) input to 3.3% of the supply voltage. Above this threshold the final output "GATE" immediately saturates at 3.3 V, otherwise it stays 0 V.

Rethinking our requirements of low voltage and power consumption, a small package, cost efficiency and reliability, we quickly settled with TI's **LMV324** operational amplifier. It features four rail-to-rail differential input operational amplifiers just so that we can realize the different signalling stages with one single IC. Obviously, the circuitry around the LMV324 will have a much higher power consumption than the digital sensors. When all four operational amplifiers are active, we have measured a typical current consumption of around 600 μA at 3.3 V, which results in a power consumption of ~ 2 mW.

ACCELEROMETER We are well aware that the LaunchPad features a 3-axis accelerometer. However, as a general purpose sensing BoosterPack, we decided to integrate one ourselves. Since Texas Instruments does not supply 3-axis accelerometers, we chose the MMA8452 from Freescale. It is a flexible and smart accelerometer with 12 bit resolution in a range of ± 2 , ± 4 or ± 8 g respectively. Moreover it features two interrupt pins with numerous embedded interrupt modes and is available as a free sample. As we use it mostly for simple orientation detection, we only sample the acceleration

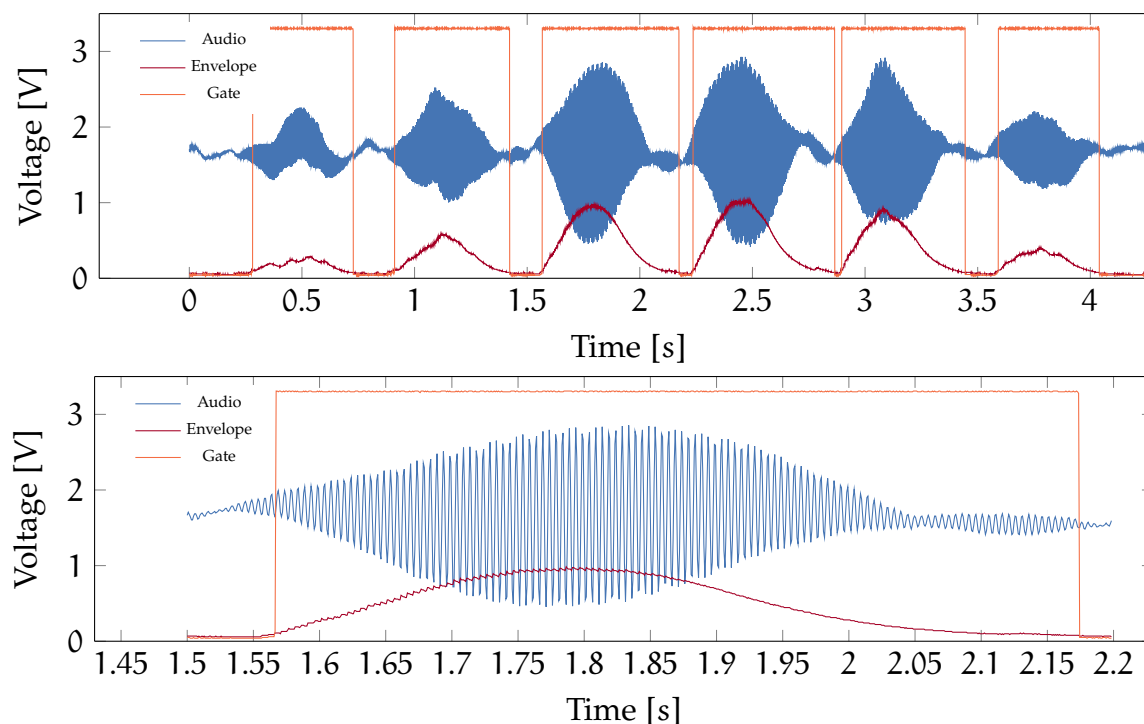

Figure 4: The three outputs “Audio”, “Envelope” and “Gate” of the sound sensor as in figure 1 over a period of 4.25 s (top) and a closeup of a shorter period (bottom) for an 100 Hz sine input with a 1.5 Hz sine amplitude modulation.

values at fairly low rates leading to a typical current consumption of approximately $80 \mu\text{A}$, i.e. about 0.25 mW . Figure 5 depicts the sensor’s output for all three axis as well as the absolute value of the acceleration in two scenarios. The measurements clearly demonstrate the impeccable functioning.

BAROMETRIC PRESSURE As an important meteorologic quantity, atmospheric pressure has an influence on a person’s mood. Since Texas Instruments does not offer barometric pressure sensors, we found the BMP180 from Bosch as well as the MPL3re115A2 from Freescale highly suitable in our research. Both have excellent resolution, low power consumption and temperature measurement included. In the end we opted for the MPL3115A2 mostly because we could order free samples, convert pressure automatically into altitude and we liked the documentation better. The MPL3115A2 features a fully compensated 20 bit pressure or altitude measurement as well as a 12 bit temperature measurement. The redundant temperature measurement serves as a check for the HDC1000. The MPL3115A2 allows for many different settings and (over)sampling rates. With a reasonable configuration we can stay well below $50 \mu\text{A}$, i.e. an average power consumption of about 0.16 mW .

ADC Of course there are uncountably many sensors one could wish for on a sensing board. Apparently we had to restrict ourselves in the selection, but we still had one more idea. While one can add arbitrarily many digital sensors to the I²C or SPI bus, we came up with a solution to also add flexibility for analog devices. We included Texas Instrument’s ADS1115, a 16 bit, four channel ADC. For each channel we provide a three pin header on the BoosterPack for power supply lanes and an

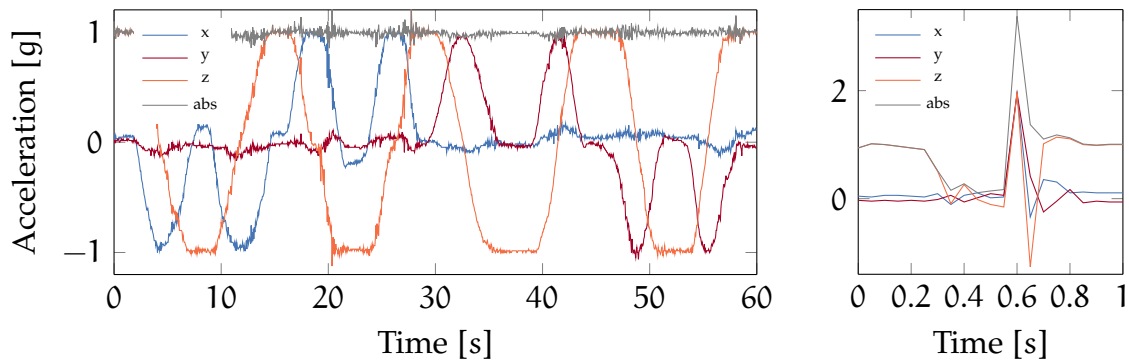

Figure 5: Left: The response when rotating slowly around all possible axis. The absolute value stays at 1 g and is constantly redistributed over combinations of different axis. Right: The response when dropping from approximately 30 cm. First we have 1 g in the z direction, then almost no force in the free fall phase and large peaks during the collision, before we are back to the initial situation.

analog signal. Thus the user can easily add up to four more analog sensors. Texas Instruments offers a great variety of ADCs for all kinds of purposes. We were looking for a small package, an I²C interface, multiple channels, low supply voltage and especially low power consumption. The [ADS1115](#) performs incredibly well in all those criteria. In continuous mode it only consumes about 0.5 μ W. It even comes with an internal oscillator and PGA. The sampling rate is definitely sufficient for most sensing applications and the resolution of 16 bit exceeds our requirements. We tested the ADC with TI's [LMT70A](#), a precision analog temperature sensor, which measures the skin temperature of the baby. Thereby we detect for instance, whether there is sufficient physical contact with the mother [8].

SUMMARY The BabyZen BoosterPack delivers precision measurements of sound pressure, temperature, humidity, ambient light, acceleration and barometric pressure from a rather small, densely packed PCB with an incredibly low power consumption. All sensors are selected carefully and have been extensively tested separately in advance. We provide the highest possible flexibility by leaving all I²C address settings to the user, connecting all available interrupt pins and offering possibilities for extensions.

2.4 Device Software

TI also offers a well tuned and specialized software stack. The SimpleLink library [9] contains everything we need in terms of connectivity, while the driver library [10] includes numerous methods for power management and cryptographic purposes, which we use to minimize power consumption and securely connect to the Azure server via HTTPS respectively.

Our philosophy of flexibility also motivated the design and implementation of the device's software. For simple access to the BoosterPack in different applications as well as extensibility, we wrote a small library that provides access to all sensors. It has been implemented using a subset of C++. Although TI offers sophisticated tools along with the Code Composer Studio for a perfect user experience, we strongly

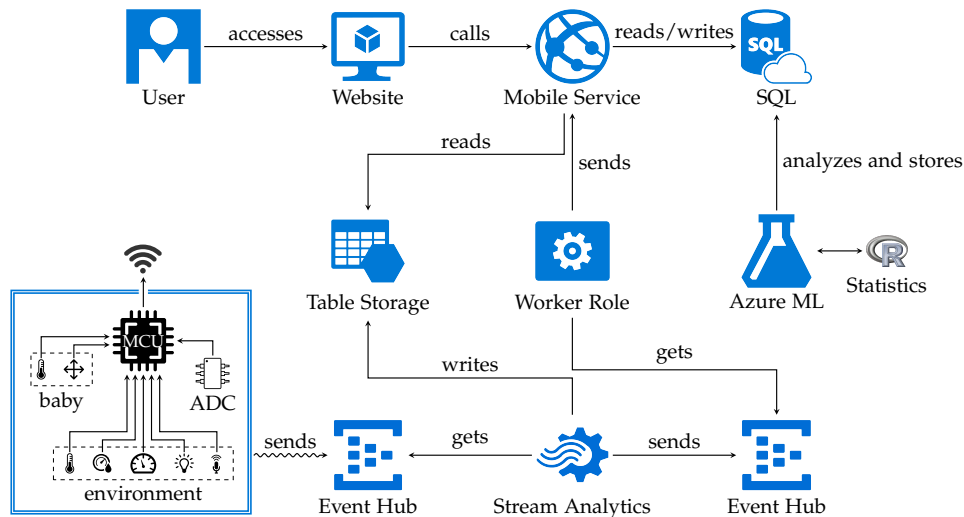

Figure 6: A diagrammatic overview of the whole BabyZen application.

encourage cross platform development. Therefore we chose the Energia IDE, which is lightweight and available for Windows, Linux and MacOS.

While the library has basically no dependency besides the standard wiring lib, our main application for BabyZen makes use of some special capabilities of the CC3200 LaunchPad. We use the WiFi chip by sending HTTPS requests. This requires using the crypto engine of the LaunchPad. We need to store and read the certificate of our target server. Additionally, the certificate is delivered with an expiration date. Since the underlying API tries to make sure that no invalid certificate is being used, we need to set the time as accurately as possible. Here we use a publicly available NTP server, which is polled once in a while.

When all data is collected and preprocessed, we serialize it to form a JSON string. Then we build the request, which involves creating a Shared Access Signature (SAS) authentication token. For this step we require the current time again. Now we are ready to send the actual HTTPS POST request. We also created some tests and inspected the device's memory to make sure that our code does not contain any memory leaks.

3 ARCHITECTURE

In the previous section we had a closer look at the hardware side. This aspect plays an important role in the overall architecture of the project. But it is only a fraction of the big picture. We also require a powerful cloud service, which is able to aggregate and evaluate the data. A proper design of the evaluation tool is obligatory. Figure 6 gives a simplistic overview of our architecture. The BoosterPack is shown figuratively in the blue double frame. We center everything around a web service, which will be provided by the Azure Mobile Services. The backend is mostly concerned with bringing the data to the Azure Machine Learning workspace and running evaluations against the data.

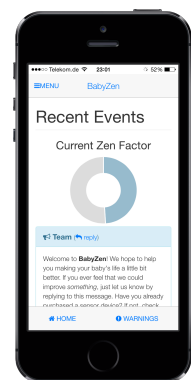

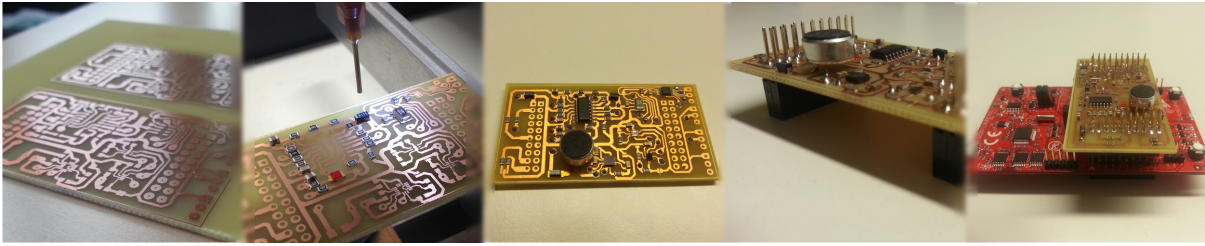

Figure 7: The development stages of the BoosterPack.

Basically the whole application is divided into three parts. In the first stage we need to transfer the data into the application, first to an intermediate location and then to an Azure Machine Learning workspace. Secondly, we store the data in Azure SQL and conduct experiments. Finally, the raw data and recommendations can be accessed via applications that communicate with our API. A live-stream of the incoming data is also possible. One of the intermediate locations is accessed by an Azure Worker Role instance, which is connected to our API via SignalR real-time communication.

As any application merely transforms an initial set of data to a final set of data, figure 6 mostly depicts the data flow. Our initial set is the raw sensor data. Our final data is stored in the Azure SQL database or computed on request via an API. More details about the software infrastructure of the project can be found in [11]. The [web page](#) of the web application is online [12].

4 CONCLUSION

We demonstrated that a fully functional low cost end-to-end IoT application can be built by two persons entirely in their free time. Texas Instruments supported the project with very developer friendly sample and shipping policies, excellent documentation of their products and a huge amount of additional material such as evaluation modules, software stacks, IDEs and application reports. It was a great learning experience to go through all stages from soldering the PCB to defining abstract machine learning models, see figure 7 and [1]. It was a particular pleasure to work with the powerful CC3200 LaunchPad and TI's software libraries, because the possibilities are endless.

The next step is to fine-tune the machine learning models for optimal recommendations, which is expected to require a lot of time and experience. In the meantime we would like to implement a more detailed analysis of the sound and accelerometer signals hoping for a clear distinction between, e.g. screaming, laughing, sleeping. Moreover, we are also excited about implementing further TI parts, such as the analog front-ends for optical heart rate monitoring or non dispersive infrared sensing to measure CO₂ levels. More refined data sets probably lead to even more accurate recommendations. Of course, we also have to evaluate practicability. Can BabyZen be seamlessly and comfortably integrated into the average parents' and baby's daily routine? How much impact can our suggestions reach and how should one actually recommend actions? Naturally the to-do list is still long, but we are very proud that we could accomplish all our ambitious goals in such a short time.

BILL OF MATERIALS

No.	Manufacturer	Part	Type	Designator	Qty. (per Board)
1	Texas Instruments	LMV324IDR	Operational Amplifier	IC1	1
2	Texas Instruments	ADS1115IDGST	16 bit, 4-channel ADC	U1	1
3	Texas Instruments	OPT3001DNPR	Ambient Light Sensor	U3	1
4	Texas Instruments	HDC1000YPAT	Temperature & Humidity Sensor	U4	1
5	Texas Instruments	LMT70AYFQR	Analog Temperature Sensor	[not on the PCB]	1
6	Freescale	MMA8452QT	Accelerometer	U2	1
7	Freescale	MPL3115A2	Pressure Sensor	U5	1
8	Multicomp	25R0618	9.7 mm Microphone	MIC9.7MM	1
9	AVX	10R6005	10 μ F Capacitor	C1, C3, C11	3
10	AVX	60R6215	1 μ F Capacitor	C2, C10	2
11	Vishay	07J8373	100 nF Capacitor	C4, C5, C6, C7, C8, C9, C12	7
12	Vishay	42K3668	100 k Ω Resistor	R3, R8, R19	3
13	Vishay	07J8373	47 k Ω Resistor	R1, R23, R24, R25, R26	5
14	Vishay	52K8286	22 k Ω Resistor	R4	1
15	Vishay	25H9887	10 k Ω Resistor	R7, R11, R17, R18	4
16	Vishay	59M6811	4.7 k Ω Resistor	R21, R22	2
17	Vishay	52K8376	3.3 k Ω Resistor	R16	1
18	Vishay	52K8228	2.2 k Ω Resistor	R6, R20	2
19	Vishay	52K8015	1 k Ω Resistor	R9, R10, R12	3
20	Vishay	25H9887	100 Ω Resistor	R5, R13, R14, R15	4
21	Vishay	-	Optional Gain Resistor	R2	1
22	Kingbright	93T1592	LED (red)	D2	1
23	NXP	1PS79SB40	Schottky Diode	D1, D3	1
24	Sparkfun	PRT-11376	10 Pin Headers	BoosterPack Headers	4
25	Molex	56H1960	3 Pin Headers	J1, J2, J3, J4	4

REFERENCES

- [1] N. Kilbertus and F. Rapp. BabyZen - Video Demonstration. <https://www.youtube.com/watch?v=f3wl8Ljz1lo>, 2015. [Online; accessed 28-July-2015].
- [2] M. Schlaud, M. Dreier, A. S. Debertin, K. Jachau, S. Heide, B. Giebe, J. P. Sperhake, C. F. Poets, and W. J. Kleemann. The German case-control scene investigation study on SIDS: epidemiological approach and main results. *International journal of legal medicine*, 124(1):19–26, 2010.
- [3] J. F. Koenig. Sleeping pad, bedding and bumpers to improve respiratory efficiency and environmental temperature of an infant and reduce the risks of sudden infant death syndrome (SIDS) and asphyxiation. 2004. US Patent 6,684,437.
- [4] C. E. Hunt. Sudden infant death syndrome and other causes of infant mortality: diagnosis, mechanisms, and risk for recurrence in siblings. *American journal of respiratory and critical care medicine*, 164(3):346–357, 2001.
- [5] Wikipedia contributors. Zen — Wikipedia, The Free Encyclopedia. <http://en.wikipedia.org/wiki/Zen>, 2015. [Online; accessed 5-June-2015].
- [6] Texas Instruments. Build your own BoosterPack. <http://www.ti.com/ww/en/launchpad/byob>, 2015. [Online; accessed 8-June-2015].
- [7] Texas Instruments. Tools and Software for the CC3200. <http://www.ti.com/product/CC3200/toolssoftware>, 2015. [Online; accessed 8-June-2015].
- [8] A. Fransson, H. Karlsson, and K. Nilsson. Temperature variation in newborn babies: Importance of physical contact with the mother. *Archives of Disease in Childhood-Fetal and Neonatal Edition*, 90(6):F500–F504, 2005.
- [9] Texas Instruments. SimpleLink CC32xx - Driver Library. http://software-dl.ti.com/ecs/cc31xx/APIs/public/cc32xx_simplelink/latest/html/index, 2015. [Online; accessed 8-June-2015].
- [10] Texas Instruments. CC3200 Peripheral Driver Library User's Guide. http://software-dl.ti.com/ecs/cc31xx/APIs/public/cc32xx_peripherals/latest/html/index, 2015. [Online; accessed 8-June-2015].
- [11] N. Kilbertus and F. Rapp. BabyZen - IoT with Azure. <http://www.codeproject.com/Articles/891868/BabyZen-IoT-with-Azure>, 2015. [Online; accessed 3-June-2015].
- [12] N. Kilbertus and F. Rapp. BabyZen - Web Application. <http://babyzen.azurewebsites.net>, 2015. [Online; accessed 31-July-2015].